

VERTICAL SLIDER

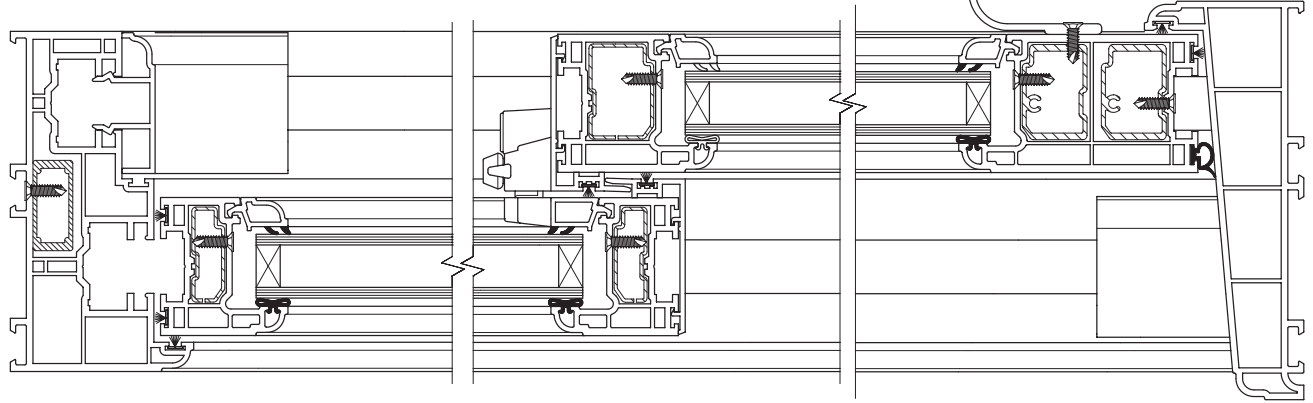

VS01
OUTER FRAME (128mm)

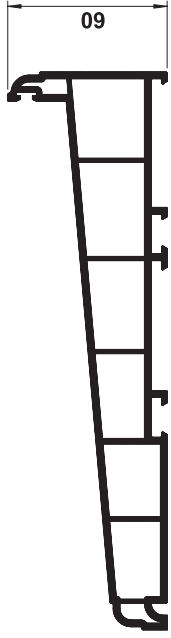
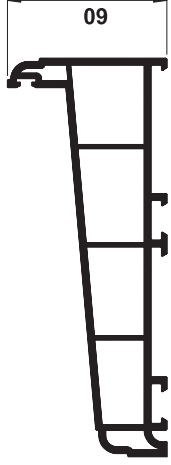
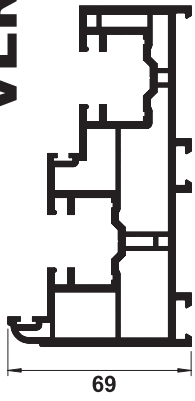
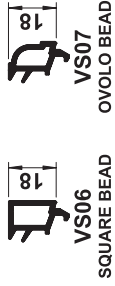
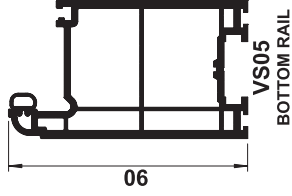
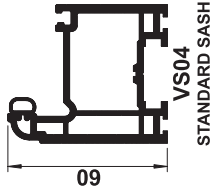
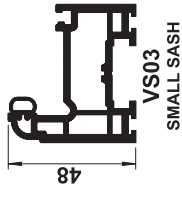

VS15
WOOLPILE INFILL

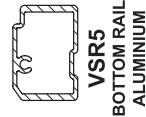

VSM02
SASH STOP END CAPS

